

CURM103-G

Reverse Voltage: 200 Volts

Forward Current: 1.0 Amp

RoHS Device

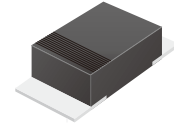

Features

- Ideal for surface mount applications.
- Easy pick and place.
- Plastic package has Underwriters Lab flammability classification 94V-0.
- Exceeds environmental standard MIL-S-19500/228.
- Low leakage current.

Mechanical data

- Case: Mini SMA/SOD-123 molded plastic
- Terminals: solderable per MIL-STD-750 , method 2026
- Polarity: Indicated by cathode band
- Mounting position: Any
- Weight: 0.04 grams (approx.).

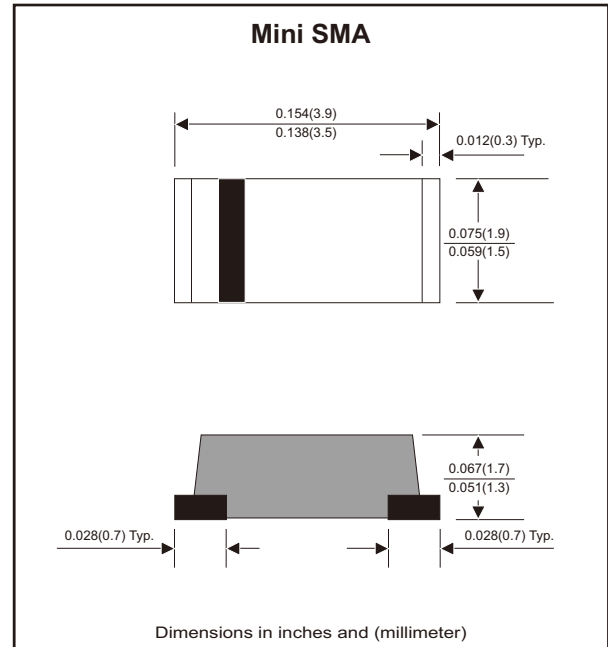

Circuit Diagram



Maximum Ratings and Electrical Characteristics

Parameter	Symbol	CURM103-G	Unit
Repetitive peak reverse voltage	V _{RRM}	200	V
Continuous reverse voltage	V _R	200	V
RMS voltage	V _{RMS}	140	V
Max. Forward surge current 8.3ms single half sine-wave superimposed on rate load (JEDEC method)	I _{FSM}	30	A
Max. Forward rectified current	I _o	1.0	A
Max. Forward voltage at I _F =1.0A	V _F	1.0	V
Max. Reverse recovery time (Note 1)	T _{rr}	50	nS
Max. Reverse current	V _R =V _{RRM} , T _J =25°C	I _R	5.0
	V _R =V _{RRM} , T _J =125°C	I _R	150
TYP. Thermal resistance (Note 1)	R _{θJA}	42	°C/W
TYP. Diode junction capacitance (F=1MHz and applied 4V DC reverse voltage)	C _J	20	pF
Operating junction temperature	T _J	-55 to +150	°C
Storage temperature	T _{STG}	-65 to +175	°C

Note 1: Reverse recovery time test Condition, I_F=0.5A , I_R=1.0A , I_{RR}=0.25A

Company reserves the right to improve product design , functions and reliability without notice.

REV:D

Rating and Characteristic Curves (CURM103-G)

Fig.1 - Typical Forward Characteristics

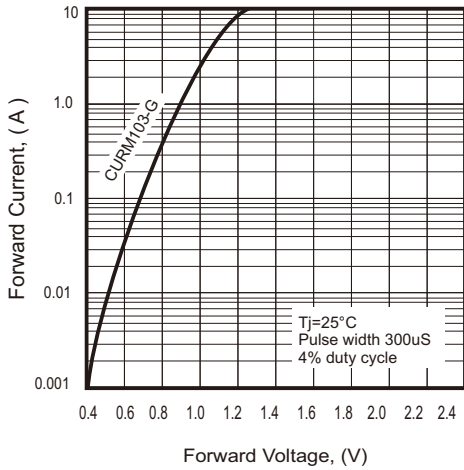

Fig. 2 - Typical Forward Current Derating Curve

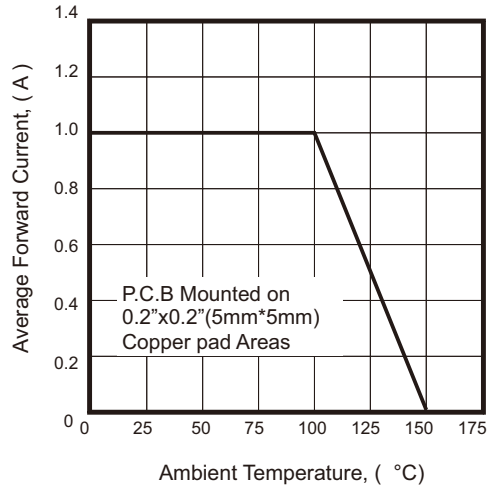
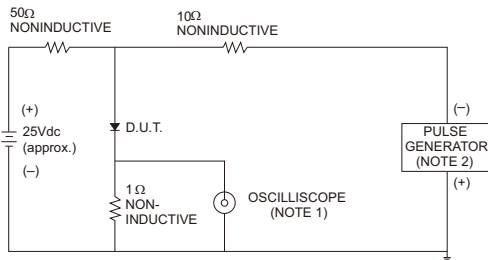

Fig. 3 - Test Circuit Diagram and Reverse Recovery Time Characteristics



NOTES: 1. Rise Time= 7ns max., Input Impedance= 1 megohm.22pF.
2. Rise Time= 10ns max., Source Impedance= 50 ohms.

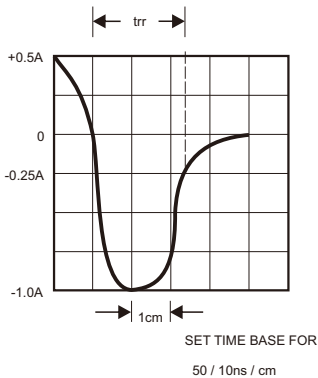

Fig. 4 - Maximum Non-Repetitive Forward Surge Current

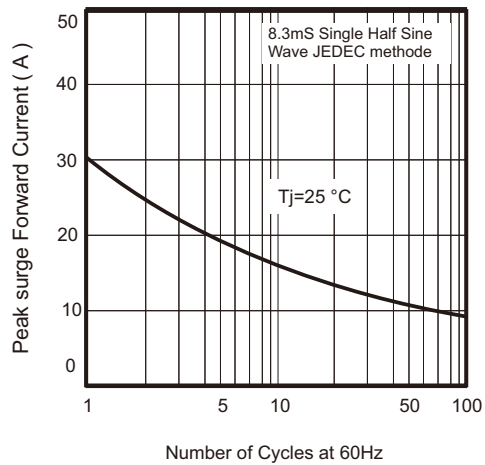
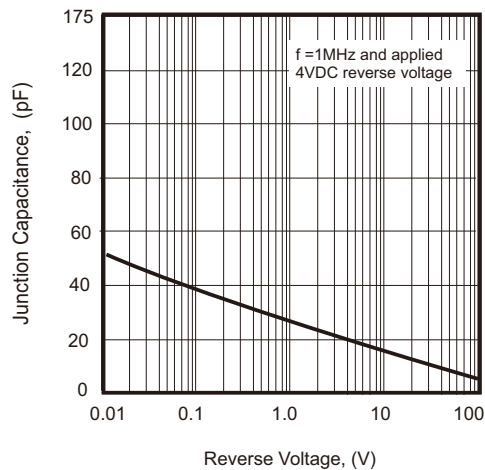
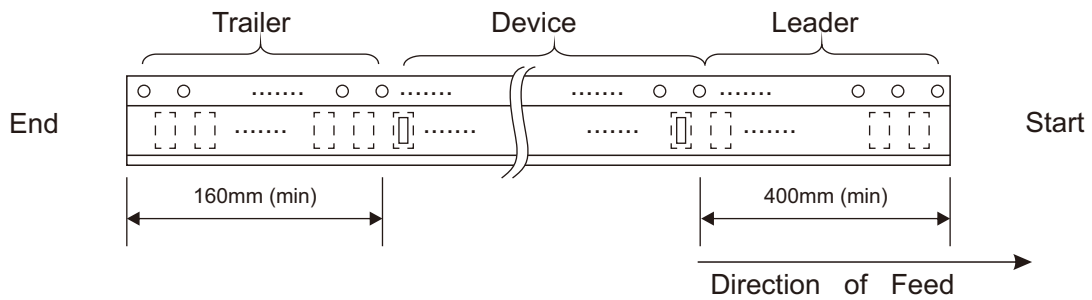
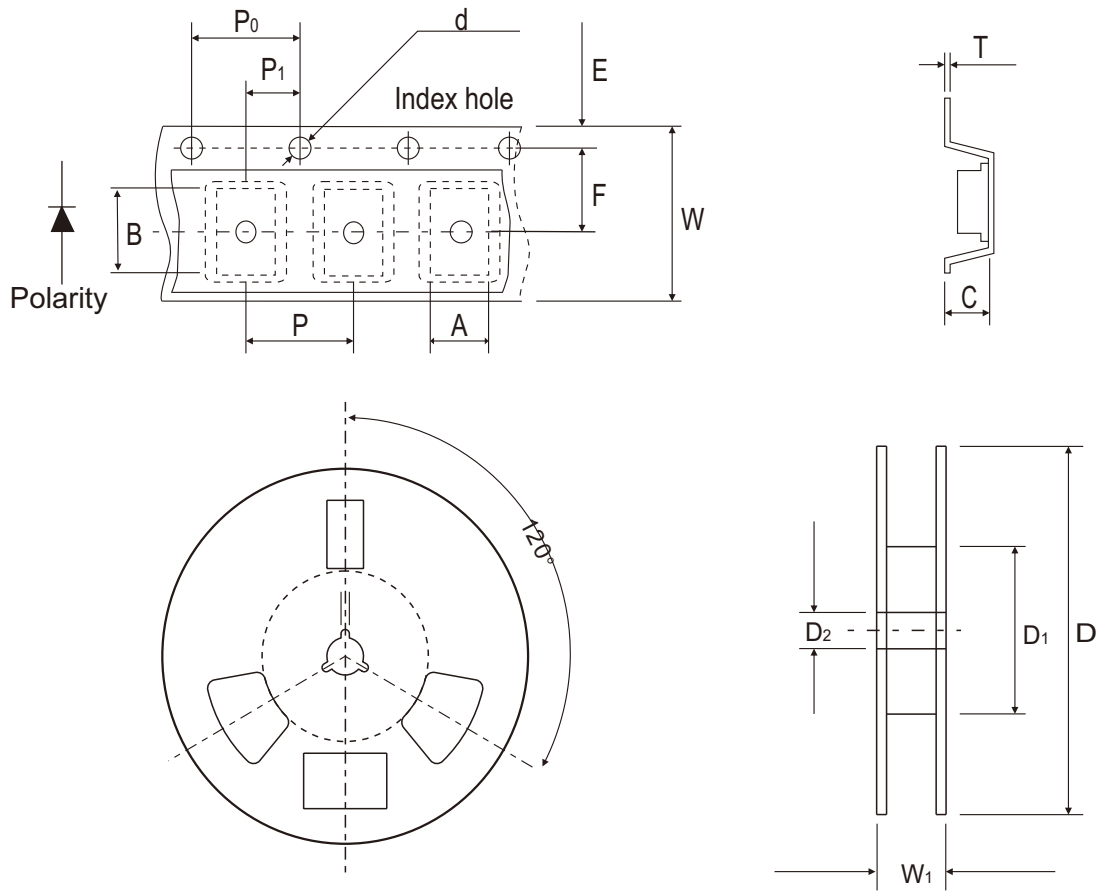

Fig.5 - Typical Junction Capacitance



Reel Taping Specification



Mini-SMA/ SOD-123	SYMBOL	A	B	C	d	D	D1	D2
	(mm)	1.90 ± 0.10	3.90 ± 0.10	1.68 ± 0.10	1.50 ± 0.10	178 ± 2.00	62.0 MIN.	13.0 ± 0.50
	(inch)	0.075 ± 0.04	0.154 ± 0.04	0.066 ± 0.04	0.059 ± 0.004	7.00 ± 0.079	2.440 MIN.	0.512 ± 0.020

Mini-SMA/ SOD-123	SYMBOL	E	F	P	P0	P1	T	W	W1
	(mm)	1.75 ± 0.10	3.50 ± 0.10	4.00 ± 0.10	4.00 ± 0.10	2.00 ± 0.10	0.23 ± 0.10	8.00 ± 0.30	11.40 ± 1.0
	(inch)	0.069 ± 0.004	0.138 ± 0.004	0.157 ± 0.004	0.157 ± 0.004	0.079 ± 0.004	0.009 ± 0.004	0.315 ± 0.012	0.449 ± 0.039

Marking Code

Part Number	Marking Code
CURM103-G	H3



XX = Product type marking code

Suggested PAD Layout

SIZE	Mini-SMA/SOD-123	
	(mm)	(inch)
A	3.30	0.130
B	1.40	0.055
C	1.90	0.075
D	4.70	0.185
E	1.90	0.075

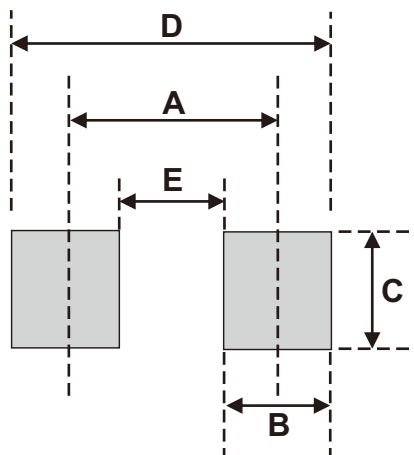

Standard Packaging

Case Type	Qty per Reel	Reel Size
	(Pcs)	(inch)
Mini-SMA/SOD-123	2,500	7